

P4-30...L100-11

Model: E12a

en Assembly and Operating Instructions

Tubular drives for sun protection systems

Important information for:

• Fitters / • Electricians / • Users

Please forward accordingly!

These instructions must be kept safe for future reference.

2010 301 096 0 14/08/2018

Becker-Antriebe GmbH
Friedrich-Ebert-Straße 2-4
35764 Sinn/Germany
www.becker-antriebe.com



BECKER

Table of contents

General	3
Warranty	3
Safety instructions	4
Instructions for the user	4
Instructions for installation and commissioning	4
Intended use	6
Assembling and disassembling the plug-in connecting cable	6
Assembling the plug-in connecting cable	6
Disassembling the plug-in connecting cable for tubular drives dia. 35	7
Disassembling the plug-in connecting cable for tubular drives dia. 45 and dia. 58	8
Installation	9
Assembling the drive	9
Undoing the mounting pin	9
Drive adapter safety catch	9
Assembling the drive adapter with safety catch on the drive shaft	9
Disassembling the drive adapter with safety catch on the drive shaft	10
Assembling and disassembling the drive adapter with separate drive adapter safety catch	10
Assembling and disassembling the drive adapter with screw connection	10
Mounting the drive in the tube	10
Setting the limit positions with the switches on the drive head	12
Deleting the limit positions with the switches	14
Adjusting the limit positions with a rotary switch or a locking button	15
Deleting the limit positions with a rotary switch or a locking button	16
Setting the limit positions using the programming unit	17
Changing the additional stop behaviour function with the programming unit	19
Deleting the limit positions using the programming unit	20
Setting the limit positions with Auto-Install	22
Torque detection	23
Activating/deactivating the additional fabric untensioning function with the programming unit	24
Activating/deactivating the additional fabric tensioning function with the programming unit	24
Information for the electrician	25
Disposal	25
Maintenance	25
Technical data dia. 35	25
Technical data dia. 45	26
Technical data dia. 58	26
Certificate of Suitability	26
What to do if...?	27
Sample wiring diagram	28

General

These tubular drives are high-quality products with the following features:

- Optimised for sun protection applications
- Installation without stops is also possible (from extended point to retracted point)
- Automatic detection of limit positions thanks to intelligent electronic system with stop systems
- Tensile load is optimally adapted to the mechanical requirements of the sun protection system
- The limit positions do not have to be reset: Changes in the shading solution are accommodated automatically when using stop systems.
- Easy setting of limit positions by pushing a button on the programming unit, via a switch on the drive, rotary switch or a locking button
- Considerably reduced stop load, and thus considerably reduced fabric load
- Activate/deactivate the fabric untensioning function
- Activate/deactivate the fabric stretching function
- Left or right-hand installation
- Several drives can be operated in parallel
- Compatible with the comprehensive range of the drive manufacturer's control units
- Compatible with existing drives with electronic limit switching (4-core connecting cable)
- Smooth operation of the system and the drive increases the service life
- For plug-in connecting cable

Please observe these Assembly and Operating Instructions when installing and setting up the equipment.



The date of manufacture comes from the first four digits of the serial number.

The numbers 1 and 2 indicate the year and the numbers 3 and 4 indicate the calendar week.

Example: 24th calendar week in 2012

Ser. No.:	1224XXXXX
-----------	-----------

Explanation of pictograms

	CAUTION	CAUTION indicates a hazardous situation which, if not avoided, could result in injury.
	ATTENTION	ATTENTION indicates measures that must be taken to avoid damage to property.
		Denotes user tips and other useful information.

Warranty

Structural modifications and incorrect installation which are not in accordance with these and our other instructions can result in serious injuries, e.g., crushing of limbs. Therefore, structural modifications may only be carried out with our prior approval and strictly in accordance with our instructions, particularly the information contained in these Assembly and Operating Instructions. Any further processing of the products which does not comply with their intended use is not permitted.

The end product manufacturer and fitter have to ensure that all the relevant current statutory, official and, in particular, EMC regulations are adhered to during utilisation of our products, especially with regard to end product manufacture, installation and customer advice.



Safety instructions

The following safety instructions and warnings are intended to avert hazards and to prevent property damage and personal injury.

Instructions for the user

General information

- The drive must be disconnected from its power source during cleaning and maintenance and when replacing parts.
- All work, including maintenance and cleaning, on electrical installations as well as other system parts must always be performed by trained technicians, in particular qualified electricians.
- Children from the age of 8 years and persons with reduced physical, sensory or mental capabilities or lack of experience and/or knowledge may use these devices, provided they are supervised or have been instructed in the safe use of the device, and have understood the hazards involved. Children must not play with the device.
- Systems have to be checked regularly by authorised specialists for wear and damage.
- Always put damaged systems out of operation immediately until they are repaired by an authorised specialist.
- Do not operate equipment if people or objects are within the danger zone.
- Observe the danger zone of the equipment during operation.
- Ensure that there is adequate clearance (at least 40 cm) between moving parts and adjacent objects.



Caution

Safety instructions for avoiding serious injuries.

- **Crushing or shearing points must be avoided or protected.**

Instructions for installation and commissioning

General information

- Observe the safety instructions in IEC 60335-2-97. Please note that this list of safety instructions is not exhaustive, since it would be impossible for the standard to include all sources of danger. For example, the design of the operated product, the way the drive works in the situation it is installed in or even the way the end product is mounted in the end user's place of use cannot be taken into consideration by the drive manufacturer.

If any questions or uncertainties regarding the safety instructions contained in the standard arise, please contact the manufacturer of the part or end product in question.

- All applicable standards and regulations for electrical installation must be complied with.
- All work, including maintenance and cleaning, on electrical installations as well as other system parts must always be performed by trained technicians, in particular qualified electricians.
- Only use spare parts, tools and accessory devices which have been approved by the drive manufacturer.
Unapproved third-party products or modifications to the system and its accessories represent a risk to your safety and the safety of others. This means that the use of unapproved third-party products, or modifications which have not been agreed with or approved by us, are prohibited. We do not accept liability for damage or injury arising from such actions.
- Position switch with OFF presetting within sight of the driven product, but away from moving parts, at a height of over 1.5 m. This must not be publicly accessible.
- Permanently mounted control devices must be positioned where they can be seen.
- Rated torque and duty cycle must be suitable for the requirements of the driven product.
Technical data - rated torque and service life can be found on the type plate of the tubular drive.

- Hazardous moving parts of the drive must be installed at a height of over 2.5 m above floor level or any other surface from which the drive can be accessed.
- To ensure safe operation of the system after commissioning, the limit positions must be correctly set/programmed in.
- Drives with a S05RN-F or O5RN-F connecting cable may be used both indoors and outdoors.
- To connect the drive to the driven part, solely mechanical accessory components made by the drive manufacturer from the current product catalogue may be used. The components must be installed in accordance with the manufacturer's instructions.
- If the drive is used for shading solutions in a specially marked area (e.g., escape routes, hazard zones, safety areas), compliance with all applicable regulations and standards must be ensured.



Caution

Safety instructions for avoiding serious injuries.

- **When electrical or electronic equipment and units are operated, certain components, e.g., the power supply unit, are live. Physical injuries or damage to property can result in the event of unauthorised interventions or failure to heed warnings.**
- **Be careful when touching the tubular drive, as it heats up during operation for technical reasons.**
- **Before installation, shut down all lines and control devices that are not essential for operation.**
- **Crushing or shearing points must be avoided or protected.**
- **When installing the drive, all-pole disconnection from the mains with a contact gap of at least 3 mm per pole must be provided (IEC 60335).**
- **If the mains connecting cable is damaged, it may only be replaced by the manufacturer. If the drive has a plug-in connecting cable, it must be replaced with the same type of mains connecting cable, which is available from the drive manufacturer.**

Attention

Safety instructions for avoiding property damage.

- **Ensure that there is adequate clearance between moving parts and adjacent objects.**
- **The drive must not be carried by the mains connecting cable.**
- **All latching connections and fastening screws on the brackets must be checked to ensure that they are secure.**
- **Ensure that nothing rubs against the tubular drive, such as shading solution attachments, screws, etc.**



Intended use

The type of tubular drive described in these instructions is intended solely for the operation of awnings, cassette awnings, screens, drop-arm awnings and conservatory shades.

It may only be used in networked systems if all the individual drives are exactly synchronised and reach the limit positions at the same time.

When mounting connection parts on the drive dia. 35 mm PXX/XX, only use screws EJOT Delta PT 40x12 WN 5454 Torx (9900 000 545 4).

For roller shutter applications, please use only the types of tubular drive designed for this purpose.

This type of tubular drive is designed for use in single systems (one drive per barrel).

The tubular drive must not be used in potentially explosive areas.

The connecting cable is not suitable for transporting the drive. Always carry the drive by the housing tube.

Other applications, uses and modifications are not permitted in order to protect the safety of the users and others, since these actions can impair the system's safety and carry the risk of personal injury and property damage. The drive manufacturer does not accept liability for damages or injury arising from such actions.

Always observe the information in these instructions when operating or repairing the system. The drive manufacturer does not accept liability for damage or injury resulting from improper usage.

Assembling and disassembling the plug-in connecting cable

Assembling the plug-in connecting cable

Insert the **dead** connecting cable into the drive head until the locating lug clicks into place in the drive. If necessary, use a suitable flathead screwdriver to assist with insertion. Set the screwdriver into one of the two plug grooves provided for this purpose.

Check that the cable is properly engaged.

C+plug

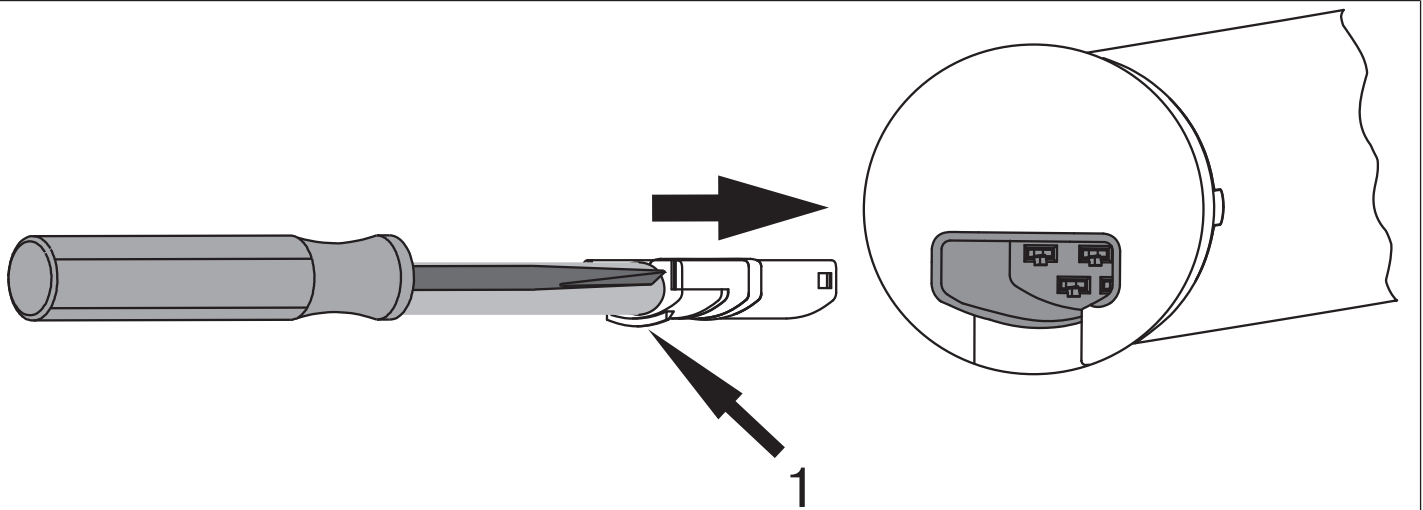

1 = locating lug

Disassembling the plug-in connecting cable for tubular drives dia. 35.



Caution

Prior to disassembly, the power supply to the connecting cable must be disconnected.

Insert a suitable flathead screwdriver between the locating lug and the snap-in pin, so that the snap-in pin releases the locating lug from the plug.

Now you can pull out the connecting cable along with the flathead screwdriver.

dia. 35

C+plug

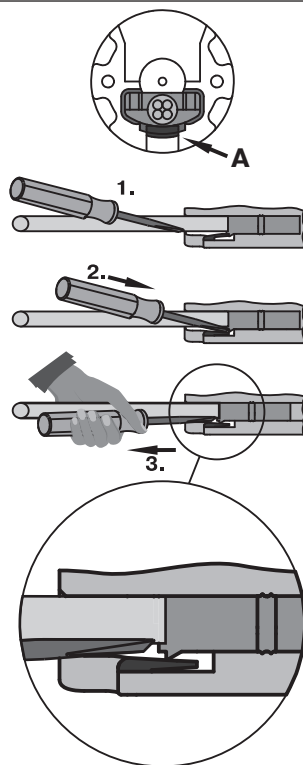

A = snap-in pin



Disassembling the plug-in connecting cable for tubular drives dia. 45 and dia. 58

 **Caution**
Prior to disassembly, the power supply to the connecting cable must be disconnected.

Insert a suitable flathead screwdriver right into the recess of the locating latch, so that the latch releases the locating lug from the plug.

Now you can pull out the connecting cable along with the flathead screwdriver.

dia. 45 and dia. 58

C+plug

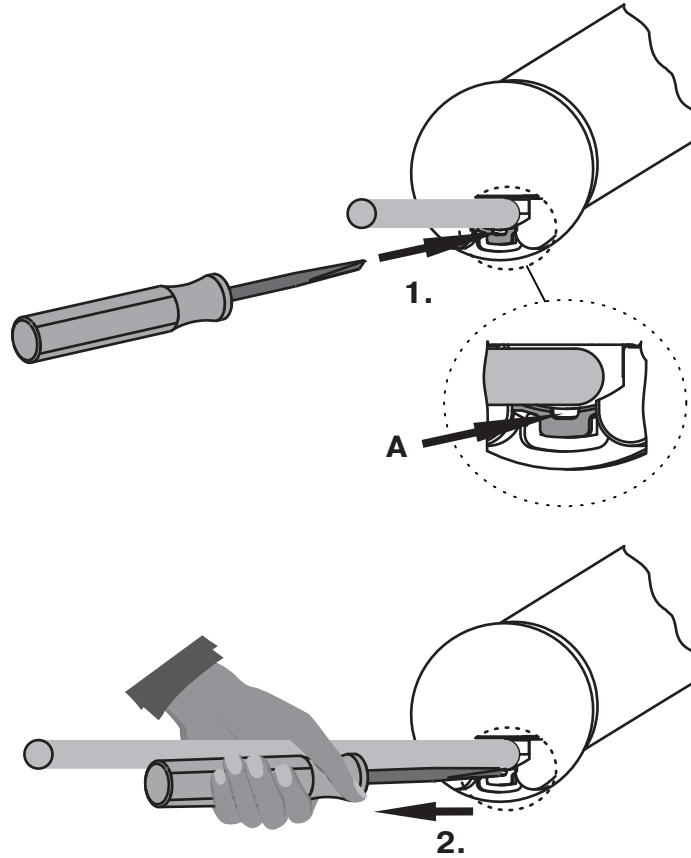

A = locating latch

Installation

Assembling the drive

Attention

To connect the drive to the driven part, solely mechanical accessory components made by the drive manufacturer from the current product catalogue may be used.

Prior to mounting, the fitter must ensure that the masonry and the system being motorised are sufficiently robust (drive torque plus weight of the shading solution).



Caution

Electrical connections may only be carried out by a qualified electrician. Prior to assembly, the power supply must be disconnected and secured. Please give the enclosed connection information to the responsible electrical contractor.

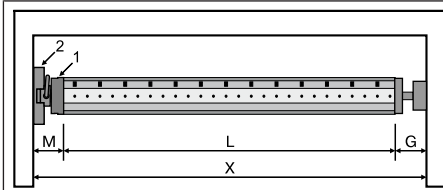

Calculate the space required at the side (M) by measuring the drive head (1) and wall bracket (2). The clear dimension of the box (X) minus the space required at the side (M) and idler (G) gives the length (L) of the barrel: $L = X - M - G$.

The space required at the side (M) varies depending on the combination of drive and wall bracket.

Then mount the wall bracket and idler. Ensure that the barrel is aligned at right angles to the wall and that sufficient axial play is allowed for the mounted system.

Undoing the mounting pin

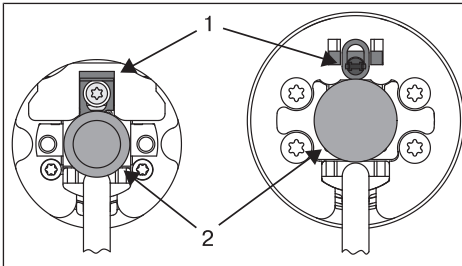

When pushed in, the mounting pin (2) locks automatically. To undo the mounting pin (2), push the tab washer (1) upwards and pull out the mounting pin (2).

Drive adapter safety catch

Assembling the drive adapter with safety catch on the drive shaft

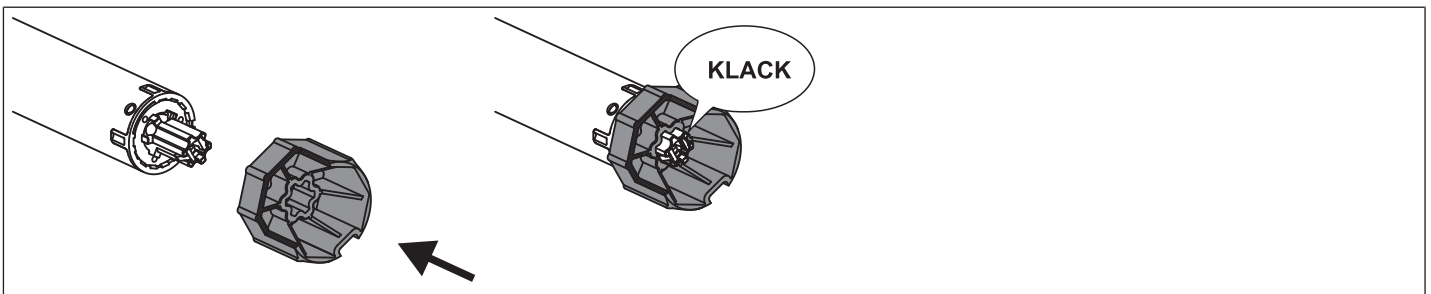

Disassembling the drive adapter with safety catch on the drive shaft

Disassembly with disassembly tool, Item no. 4930 300 606 0

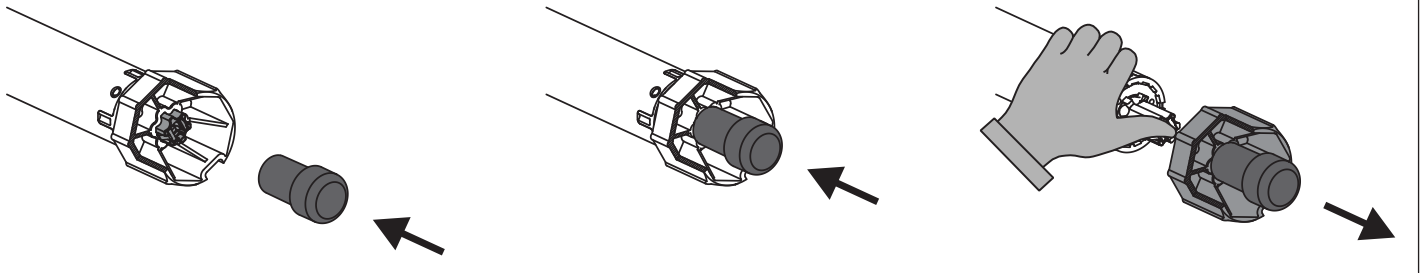

Disassembly with long nose pliers

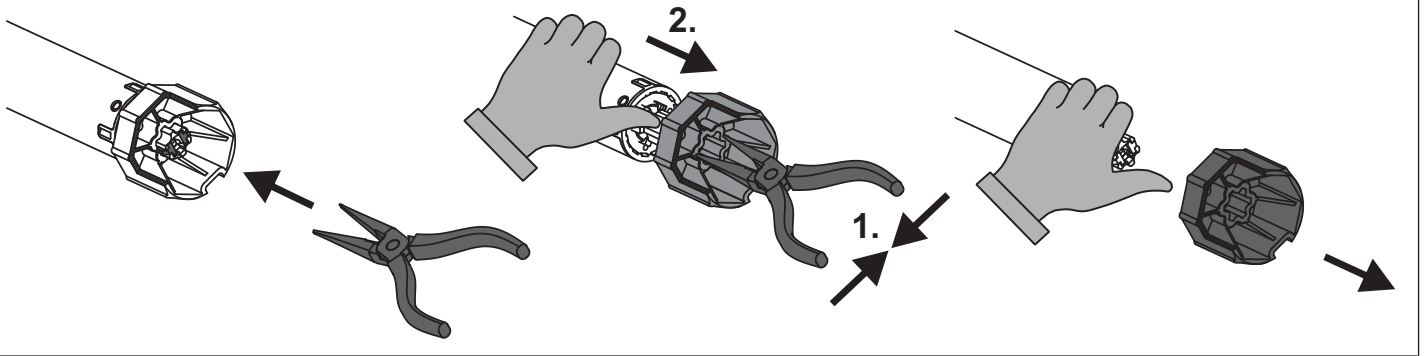

Assembling and disassembling the drive adapter with separate drive adapter safety catch

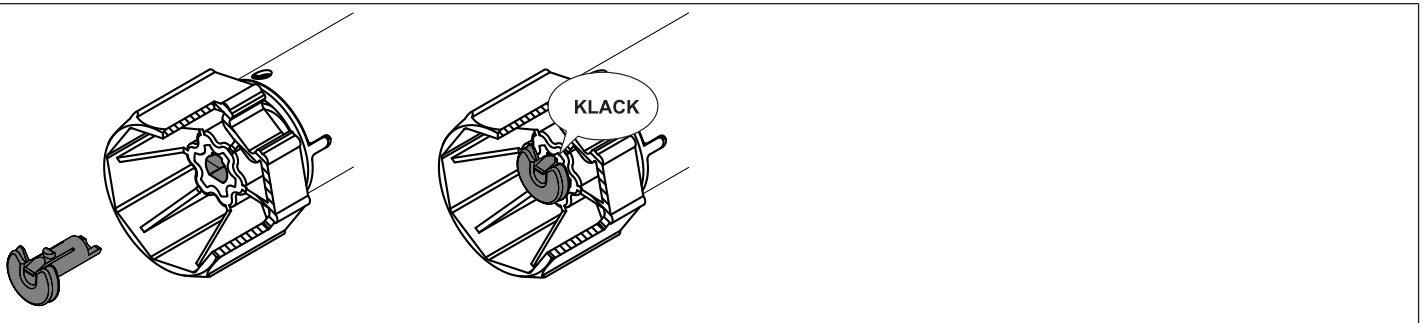

Assembling and disassembling the drive adapter with screw connection

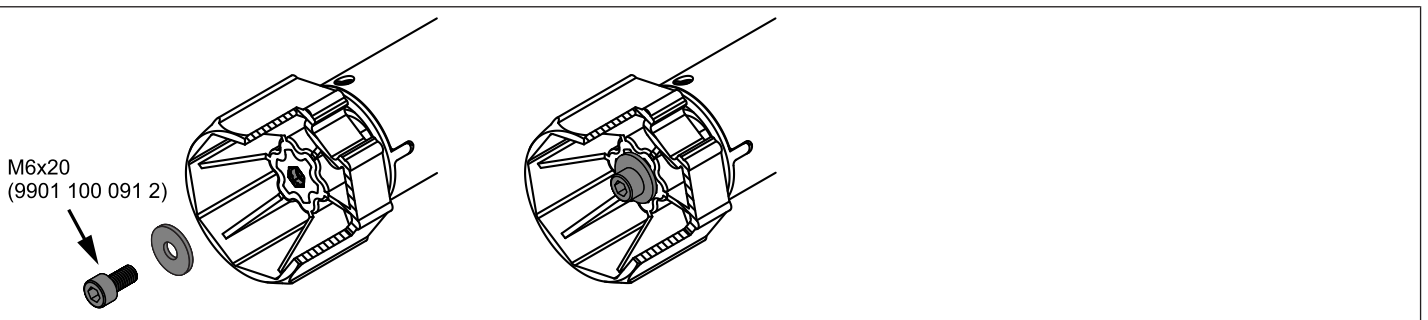

Mounting the drive in the tube

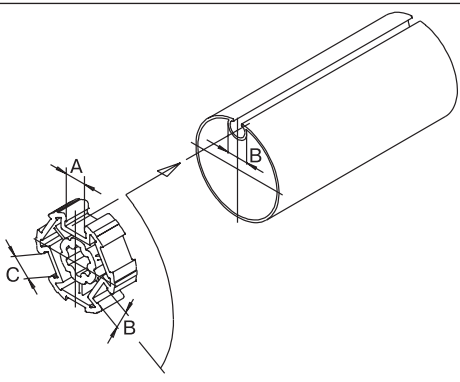

For profile tubes:

In the case of some drive adapters, tolerances of the groove widths in different barrels can be offset by rotating the drive adapter into a different groove recess. These groove recesses have different sizes and allow the drive to fit exactly.

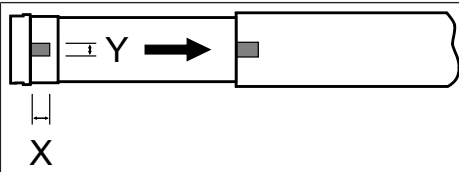

For round shafts:

Measure the lug of the thrust ring (X, Y). Then notch the tube on the motor side, so the lug of the thrust ring can also be pushed into the shaft. There must be no play between the lug of the thrust ring and the shaft.

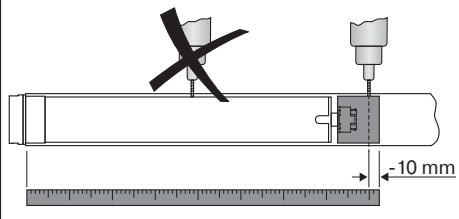

To ensure secure torque transmission for round shafts, we recommend screwing the drive adapter to the shaft (see the table below).

Attention! When drilling into the barrel, never drill near the tubular drive!

Size of drive [mm]	Drive adapter	Torque max. [Nm]	Fastening screws (4 units)
dia. 35-dia. 45	All	Up to 50	Self-tapping screw dia. 4.8 x 9.5 mm
dia. 58	Aluminium drive adapter	Up to 120	Countersunk screw M8 x 16 mm
dia. 58	diecast drive adapter	Up to 120	Self-tapping screw dia. 6.3 x 13 mm

We also recommend screwing the idler to the barrel.

Attention

Do not hammer the tubular drive into the tube or drop it into the barrel!

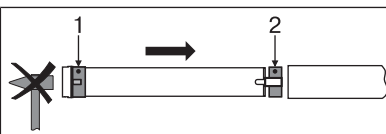

Assemble the tubular drive with the relevant ring (1) and drive adapter (2). If the ring has several grooves, select the groove which is a perfect fit and push the ring (1) onto the thrust ring.

Insert the tubular drive with the pre-assembled ring (1) and drive adapter (2) into the tube to achieve a form fit. Ensure that the ring and drive adapter are secure in the tube.

Mount the assembled unit comprising barrel, tubular drive and idler on the box and secure the drive with a split or spring pin according to the type of wall bracket fixing.

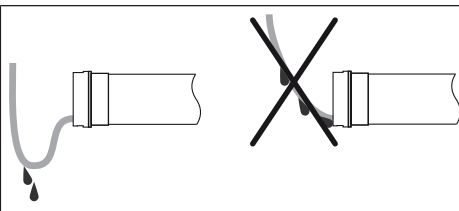

Lay the connecting cable

Lay the connecting cable up to the tubular drive, and fix. The connecting cable and any antennae must not project into the winding chamber. Cover any sharp edges.



Setting the limit positions with the switches on the drive head

Intelligent installation management

Limit position status indicator

A brief stopping and restarting indicates that no limit position has been set in that direction of movement.

Completion of installation following automatic setting of limit position "Stop"

The drive saves the limit position "Stop" permanently once the it has been reached 3 times in succession. Installation is then complete.

Setting the limit positions

There are several ways to set the limit positions:

- Extended point to retracted point
- Extended point to retracted stop

The limit position becomes fixed after the tubular drive has turned off automatically in the desired position three times.

i If the tubular drive switches off prematurely while extending/retracting, due to an obstruction, the obstruction can be cleared by extending/retracting the screen and removing the obstruction. The upper limit position can be set by extending/retracting again.

Attention



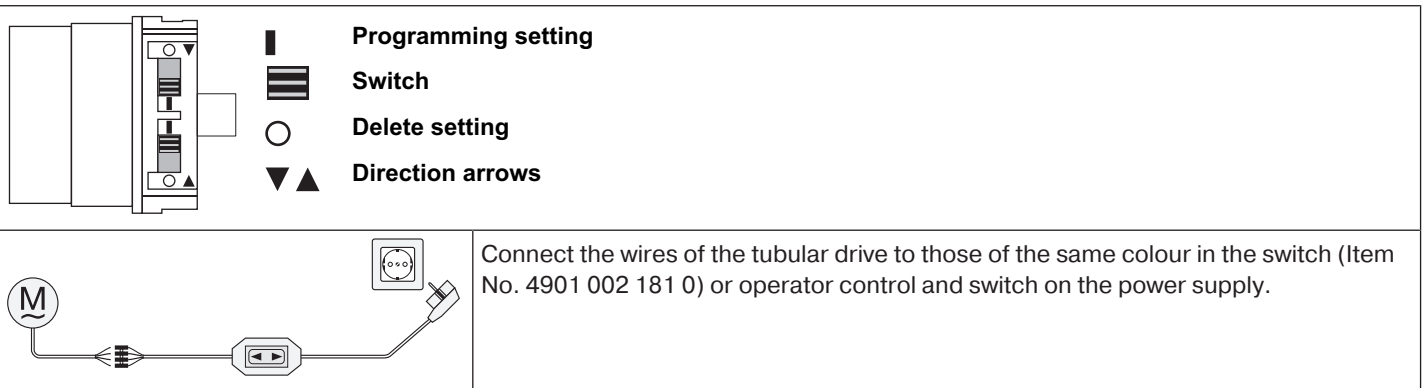

The switch is not suitable for continuous operation and has only been designed for start-up.





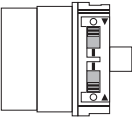

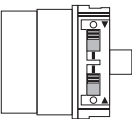
Extended point to retracted point

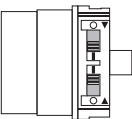

There is no shading solution length adjustment with this limit position setting.

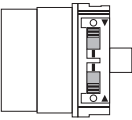
	Set both switches to the delete setting .
	Execute a short drive command.
	Open to the desired extended limit position.
	Change the setting of the extending direction of rotation switch from the delete setting to the programming setting.
	Then open to the desired retracted limit position.
	Now change the setting of the retracting direction of rotation switch from the delete setting to the programming setting. ► The limit positions are now set.

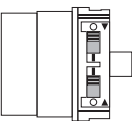
Extended position to retracted stop

	Set both switches to the delete setting .
	Execute a short drive command.
	Open to the desired extended limit position.
	Change the setting of the extending direction of rotation switch from the delete setting to the programming setting.
	Then retract to the upper permanent stop until the tubular drive switches off automatically. ► The limit positions are now set.



Deleting the limit positions with the switches

Deleting individual limit positions

i It is only possible to delete an individual limit position if the extended point to retracted point was programmed with the switches. Any additional functions that have been set are retained.

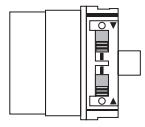

Change the setting of the switch of the relevant limit position from the programming setting to the delete setting.



Execute a short drive command.

- ▶ The limit position is now deleted.

Deleting both limit positions

i Any additional functions that may have been set are deleted at the same time, or are reset to the factory default settings.

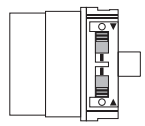

Reset both switches from the programming setting to the delete setting.



Execute a short drive command.

- ▶ Both limit positions are deleted.

Adjusting the limit positions with a rotary switch or a locking button

Intelligent installation management

Limit position status indicator

A brief stopping and restarting indicates that no limit position has been set in that direction of movement.

Completion of installation following automatic setting of limit position "Stop"

The drive saves the limit position "Stop" permanently once the it has been reached 3 times in succession. Installation is then complete.

Setting the limit positions







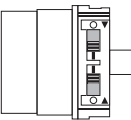

There are several ways to set the limit positions:

- Extended point to retracted point
- Extended point to retracted stop

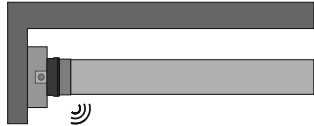

i If the tubular drive switches off prematurely while extending/retracting, due to an obstruction, the obstruction can be cleared by extending/retracting the screen and removing the obstruction. The upper limit position can be set by extending/retracting again.

Extended point to retracted point

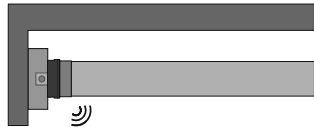
i There is no shading solution length adjustment with this limit position setting.

	Set both switches to the programming setting.
	Open to the desired extended limit position.
Carry out the following sequence without interruption between the individual drive commands.	
▷ The tubular drive confirms.	
  	
1 s 1 s until STOP and hold until	
	Then open to the desired retracted limit position.
Carry out the following sequence without interruption between the individual drive commands.	
▷ The tubular drive confirms.	
  	
1 s 1 s until STOP and hold until	
The limit positions are now set.	

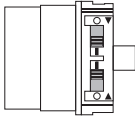
Extended point to retracted stop

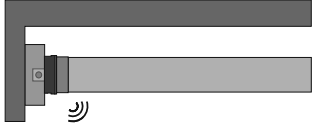
	Set both switches to the programming setting.
▼	Open to the desired extended limit position.
<p>Carry out the following sequence without interruption between the individual drive commands.</p> <p>▷ The tubular drive confirms.</p>	
 <p>▲ 1 s ▲ 1 s ▼ until STOP and hold until</p>	
▲	<p>Then retract to the permanent upper stop. During travel, the limit position status indicator (LSI) must be displayed before the limit position is reached.</p> <p>▷ The tubular drive switches off automatically.</p>
The limit positions are now set.	

Deleting the limit positions with a rotary switch or a locking button

i The switching commands sequence must be carried out in quick succession. Any additional functions that have been set are retained.

Carry out the following deletion sequence without interruption between the individual drive commands:

 <p>▲ 1 s ▼ 1 s ▼ 1 s ▲ 1 s ▼ 1 s ▲ 1 s ▲ 1 s ▼ until</p>	 <p>■ STOP</p>
--	--

The tubular drive confirms.
Both limit positions are deleted.

Setting the limit positions using the programming unit

Intelligent installation management

Limit position status indicator

A brief stopping and restarting indicates that no limit position has been set in that direction of movement.

Completion of installation following automatic setting of limit position "Stop"

The drive saves the limit position "Stop" permanently once the it has been reached 3 times in succession. Installation is then complete.

Setting the limit positions

There are several ways to set the limit positions:

- Extended point to retracted point
- Extended point to retracted stop

The limit position becomes fixed after the tubular drive has turned off **automatically** in the desired position three times.



If the tubular drive switches off prematurely while extending/retracting, due to an obstruction, the obstruction can be cleared by extending/retracting the screen and removing the obstruction. The upper limit position can be set by extending/retracting again.

Attention



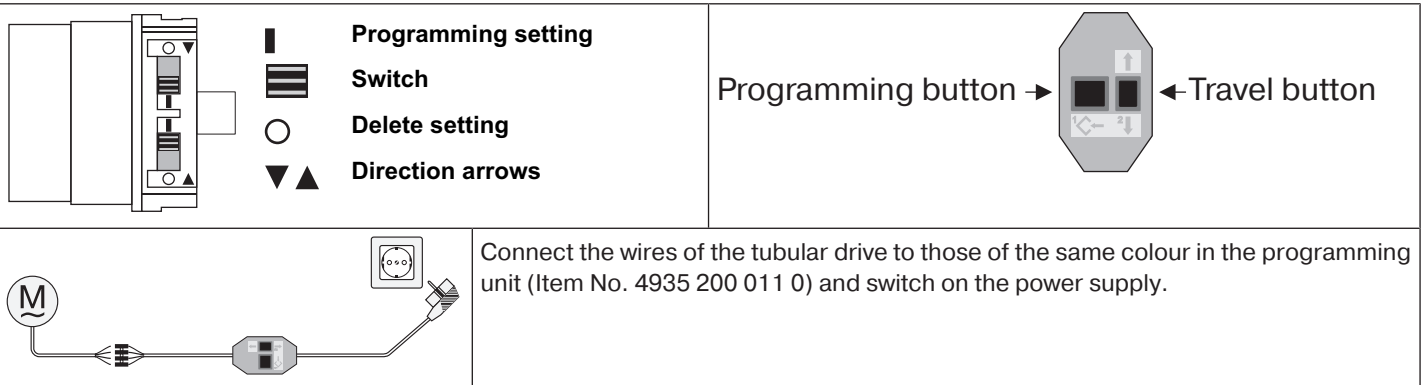

The programming unit is only designed for the commissioning, not for continuous operation.





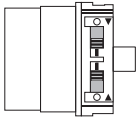

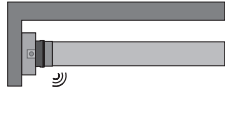
Extended point to retracted point with programming unit

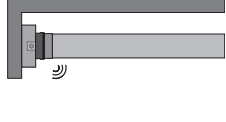

There is no shading solution length adjustment with this limit position setting.

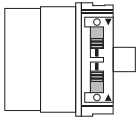
		<p>Set both switches to the programming setting.</p>
		<p>Open to the desired extended limit position.</p>
		<p>Press the programming button of the programming unit for 3 seconds.</p> <ul style="list-style-type: none"> ▷ The tubular drive confirms.
		<p>Then open to the desired retracted limit position.</p>
		<p>Press the programming button of the programming unit for 3 seconds.</p> <ul style="list-style-type: none"> ▷ The tubular drive confirms. ▶ The limit positions are now set.

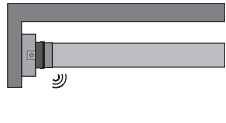
Extended point to retracted stop with programming unit





		<p>Set both switches to the programming setting.</p>
		<p>Open to the desired extended limit position.</p>
		<p>Press the programming button of the programming unit for 3 seconds.</p> <ul style="list-style-type: none"> ▷ The tubular drive confirms.
		<p>Then retract to the permanent upper stop.</p> <ul style="list-style-type: none"> ▷ The tubular drive switches off automatically. ▶ The limit positions are now set.

Changing the additional stop behaviour function with the programming unit

On delivery, the 35 diameter drive types have a reduced stop behaviour, and the 45 diameter and 58 diameter drive types have an increased stop behaviour.

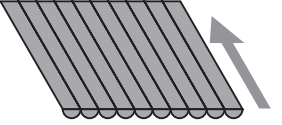
Proceed as follows to change the stop behaviour:

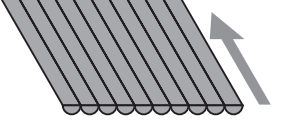
i The "to retracted stop" limit position must be set in order to adjust the stop behaviour. The stop behaviour can be changed during the first 3 runs towards the stop.





		<p>Press the retract button in order to retract the sun protection system.</p>
		<p>While retracting, also press the programming button until the tubular drive switches off automatically at the stop, and continue holding the two buttons down until confirmation is complete.</p>
		<p>Confirmation is provided by one or two shifts. 1 shift = reduced stop behaviour 2 shifts = increased stop behaviour</p>

Deleting the limit positions using the programming unit

i Connect the wires of the tubular drive to those of the same colour in the programming unit and switch on the power supply.
Please pause for 1 sec after the last drive command before beginning the deletion sequence. Also leave a pause of 1 sec between the individual steps of the deletion sequence.

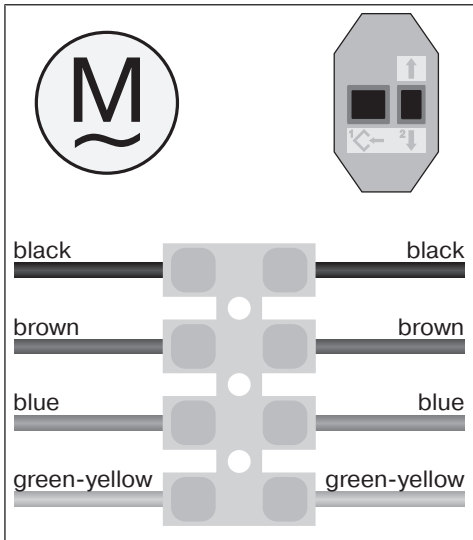
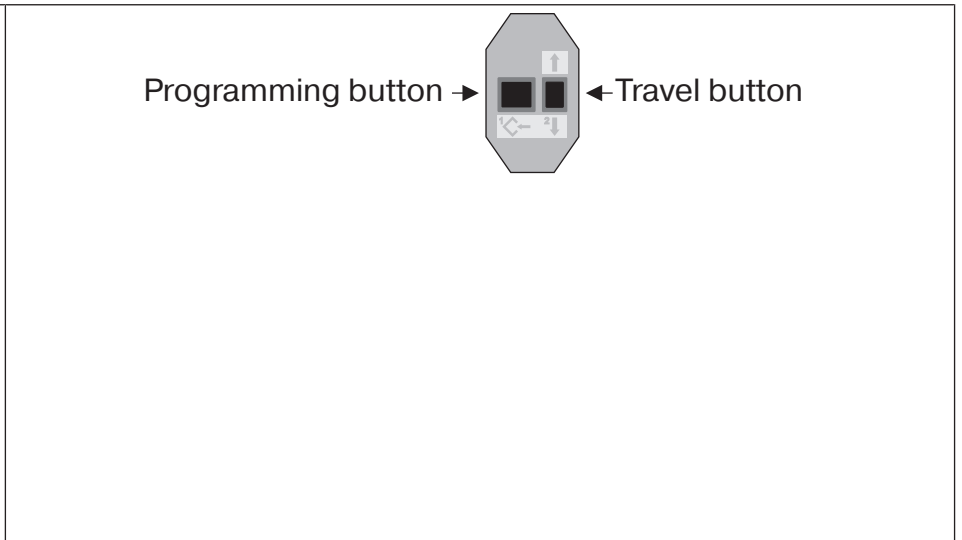
Deleting a limit position when 2 limit positions are programmed

i Any additional functions that have been set are retained.

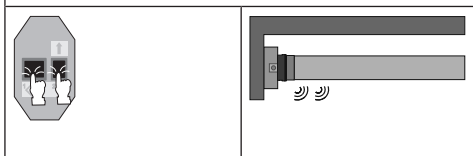
	
	<p>Open/close to the limit position to be deleted.</p>
	<p>Press the programming button and keep it pressed.</p>
	<p>Then press down the travel button and keep it pressed.</p>
	<p>Now release the programming button, but continue to keep the travel button pressed.</p>
	<p>Next press the programming button again.</p> <ul style="list-style-type: none"> ▸ The tubular drive confirms. ▸ The limit position is now deleted.

Deleting both limit positions

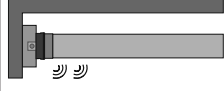

Any additional functions that may have been set are deleted at the same time, or are reset to the factory default settings.

	<p>Open/close the shading solution to a point between the limit positions.</p>
	<p>Press the programming button and keep it pressed.</p>
	<p>Then press down the travel button and keep it pressed.</p>
	<p>Now release the programming button, but continue to keep the travel button pressed.</p>
	<div style="display: flex; align-items: center;">  <div> <p>Next press the programming button again.</p> <ul style="list-style-type: none"> ▶ The tubular drive confirms. ▶ Both limit positions are deleted. </div> </div>



Setting the limit positions with Auto-Install

Intelligent installation management

Limit position status indicator

A brief stopping and restarting indicates that no limit position has been set in that direction of movement.

Completion of installation following automatic setting of limit position "Stop"

The drive saves the limit position "Stop" permanently once the it has been reached 3 times in succession. Installation is then complete.

Setting the limit positions

There are several ways to set the limit positions:

- Start point to retracted stop
- Auto point to retracted stop (only with articulated-arm awnings)

i These settings can be programmed using a suitable operating control, e.g. a rotary switch, programming unit etc.
 These tubular drives are designed for short-time operation (for the operating mode, please see technical data).
 The number of cycles an awning is capable of depends on the barrel diameter and awning extension.
 The drive running time is cut short if the drive has not cooled down fully after the previous use.

Start point to retracted stop

	Set both switches to the programming setting.	
	Use the operator control to move the sun protection system to the desired maximum projection. This must be at least 2.5 revolutions of the barrel away from the retracted limit position. At this time, it is still possible to amend the position.	
	Stop the sun protection system at this point.	
	<p>Then, retract the sun protection system without interruption until the tubular drive switches off automatically.</p> <p>Installation is now complete; electronic limit switching has saved the limit positions. As a final check, run the sun protection system to the two limit positions again.</p> <p>To ensure that the limit position is reliably detected and the sun protection system is fully closed, the tubular drive pulls the cloth slightly more strongly during the installation.</p>	

Auto point to retracted stop (only with articulated-arm awnings)

Attention

Ensure that the cloth is not wound up the wrong way by the barrel.

		<p>Set both switches to the programming setting.</p>
		<p>Extend the articulated-arm awning until the articulated arms are fully protracted and the cloth is lying loosely over them.</p>
		<p>Stop the articulated-arm awning at this point.</p>
<p>NONSTOP !</p>	<p>NONSTOP !</p>	<p>Then, retract the articulated-arm awning without interruption until the tubular drive switches off automatically.</p> <p>Installation is now complete; electronic limit switching has saved the limit positions. As a final check, run the sun protection system to the two limit positions again.</p> <p>To ensure that the limit position is reliably detected and the sun protection system is fully closed, the tubular drive pulls the cloth slightly more strongly during the installation.</p>

Torque detection



A correctly installed tubular drive reacts to extraordinarily large increases in load during operation between the limit positions and thereby prevents an overload of the tubular drive.



Activating/deactivating the additional fabric untensioning function with the programming unit

i The "to retracted stop" limit position must be set for the fabric untensioning function.

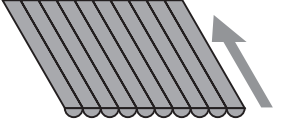

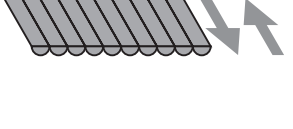



On delivery, the fabric untensioning function is deactivated.

		To activate/deactivate it, move to the Retract limit position.
		Press the programming button for approx. 5 seconds. <ul style="list-style-type: none"> ▸ Confirmation is provided by a shift. ▸ The fabric untensioning function is now activated/deactivated.

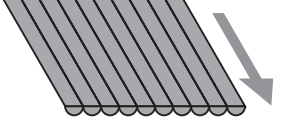

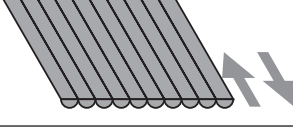
Activating/deactivating the additional fabric tensioning function with the programming unit

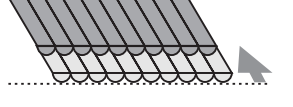
On delivery, the fabric tensioning function is deactivated.

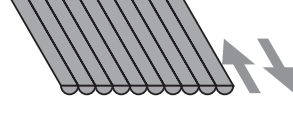
Activating the fabric tensioning function

		To activate it, move to the Extend limit position.
		Press the programming button for approx. 5 seconds. <ul style="list-style-type: none"> ▸ Confirmation is provided by a shift.
		Now move to the position where the fabric has the desired tension.
		Press the programming button for approx. 5 seconds. <ul style="list-style-type: none"> ▸ Confirmation is provided by a shift. ▸ The fabric tensioning function is now active.

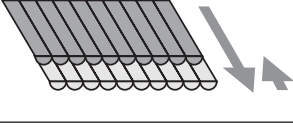
Deactivating the fabric tensioning function

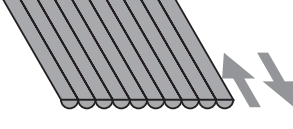
		To deactivate it, move to the fabric tensioning limit position.
		Press the programming button for approx. 5 seconds. <ul style="list-style-type: none"> ▸ Confirmation is provided by a shift. ▸ The fabric tensioning function is now deactivated.

Information for the electrician

Tubular drives with electronic limit switching can be connected in parallel. The maximum switching contact load of the switching equipment (timer, relay control, switch, etc.) must be observed. To operate drives with electronic limit switching, only use switching elements (timers) that are **not** earthed via the drive. The outputs of the switching element must be potential-free in the neutral position.

Use external conductor L1 to control the up and down direction. Other devices or consumers (lamps, relays, etc.) must not be directly connected to the drive connecting cables. For this purpose, the drives and additional devices must be decoupled by relay controls.

When installing the drive, all-pole disconnection from the mains with a contact gap of at least 3 mm per pole must be provided.

Attention

Only use mechanically or electrically locked switching elements with a marked zero position! This also applies when drives with electronic and mechanical limit switching are used in the same system. The changeover time for switching the running direction must be at least 0.5 s. The switch and control must not execute simultaneous UP and DOWN commands. Protect the electrical connections from damp.

Once you have finished wiring everything to the control, ALWAYS check the right direction assignment of the drive to the control buttons UP and DOWN, EXTEND and RETRACT.

If the drive is to be operated with devices which contain sources of interference, the electrician must ensure suitable interference suppression for the relevant devices.

Disposal

This product is made of various materials which must be disposed of properly. Find out about the applicable regulations on recycling or disposal for this product in your country.

The packaging material must be disposed of properly.

Maintenance

These drives are maintenance-free.

Technical data dia. 35

Tubular drive	P4-30
Model	E12a
Type	C PS V1 A
Rated torque [Nm]	4
Output speed [rpm]	30
Limit switch range	64 revolutions
Supply voltage	240 V AC / 50 Hz
Connected load [W]	110
Rated current consumption [A]	0.45
Operating mode	S2 4 min
Degree of protection	IP 44
Min. tube inside diameter [mm]	37
Emission sound pressure level [dB(A)]	≤ 70



Technical data dia. 45

Tubular drive	R12-17	R30-17	R40-17	R50-11
Model	E12a			
Type	C PS+ V1 A			
Rated torque [Nm]	12	30	40	50
Output speed [rpm]	17	17	17	11
Limit switch range	64 revolutions			
Supply voltage	240 V AC / 50 Hz			
Connected load [W]	120	210	260	240
Rated current consumption [A]	0.50	0.95	1.10	1.00
Operating mode	S2 4 min			
Degree of protection	IP 44			
Min. tube inside diameter [mm]	47			
Emission sound pressure level [dB(A)]	≤ 70			

Technical data dia. 58

Tubular drive	L60-11	L80-11	L100-11
Model	E12a		
Type	C PS+ V1 A		
Rated torque [Nm]	60	80	100
Output speed [rpm]	11	11	11
Limit switch range	64 revolutions		
Supply voltage	240 V AC / 50 Hz		
Connected load [W]	250	310	450
Rated current consumption [A]	1.05	1.30	1.95
Operating mode	S2 4 min		
Degree of protection	IP 44		
Min. tube inside diameter [mm]	60		
Emission sound pressure level [dB(A)]	≤ 70		

Certificate of Suitability

	Certificate No.: SAA181406
--	----------------------------

What to do if...?

Problem	Remedy
Tubular drive overruns the limit position or does not reach the set limit position.	Repair electrical installation and re-program limit positions.
	Check electrical installation; remove external devices; reset limit positions.
	Stops have broken off or one or several attachments are broken. Repair system; reset tubular drive, then re-program limit positions.
Tubular drive stops arbitrarily; cannot be restarted in the same direction.	Use a more powerful tubular drive.
	Ensure that the sun protection system runs smoothly.
Tubular drive does not run in the right direction.	Tubular drive is overheated. The tubular drive is operational again after a few minutes.
	Tubular drive is faulty (does not work even after standing still for a long period of time). Replace the tubular drive.
	Clear and remove the obstruction and set the drive in the direction required.
	Check the electrical connection.
Tubular drive only runs for approx. 1 second.	Tubular drive is faulty. Replace the tubular drive.
When you attempt to set the limit positions using the programming unit, this does not work.	<p>The limit positions were previously set using the switches. Set both switches to the delete setting.</p> <p>Execute a short drive command.</p> <p>Set both switches to the programming setting simultaneously.</p> <p>Re-set the limit positions using the programming unit.</p>
When you attempt to set the limit positions using the switches, this does not work.	<p>Set both switches to the delete setting.</p> <p>Execute a short drive command.</p> <p>Re-set the limit positions.</p>
The tubular drive switches off automatically before the first required limit position (lower limit position) is programmed.	<p>Tubular drive has detected a torque increase.</p> <p>Clear and remove the obstruction. Then move past this position to the desired limit position.</p>
When you attempt to set the limit positions using Auto-install, this does not work.	Close to the desired extended limit position and set a point.
The stop behaviour cannot be changed.	Move to the stop limit position, and delete them individually using the programming unit. Move the sun protection system to a point between the limit positions. You can now change the stop behaviour.



Sample wiring diagram

Controlling one/several drive(s) via a single switch/button

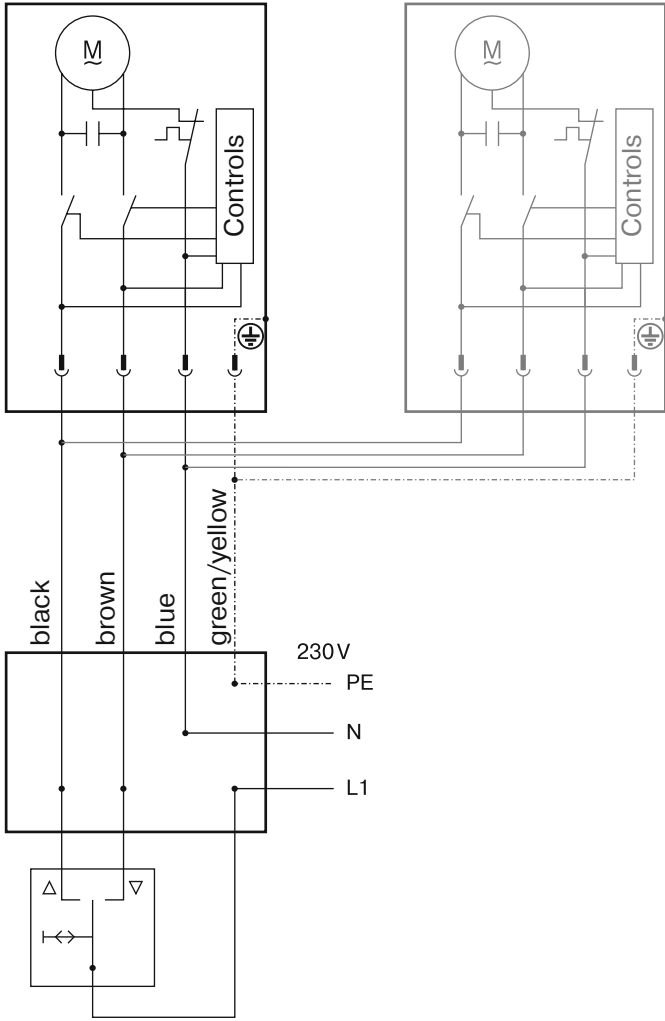







BECKER