

# R7/17

## Version: M A

### **en** Assembly and Operating Instructions

## **Roller shutter and sun protection drives with mechanical limit switch**

Important information for:

• Fitters / • Electricians / • Users

Please forward accordingly!

These instructions must be kept safe for future reference.

2010 301 104 0 14/08/2018

Becker-Antriebe GmbH  
Friedrich-Ebert-Straße 2-4  
35764 Sinn/Germany  
[www.becker-antriebe.com](http://www.becker-antriebe.com)



# **BECKER**

## Table of contents

General .....	3
Warranty .....	3
Safety instructions .....	4
Instructions for the user .....	4
Instructions for installation and commissioning.....	4
Intended use .....	6
Installation.....	6
Assembling the drive .....	6
Undoing the mounting pin.....	6
Drive adapter safety catch .....	7
Assembling the drive adapter with safety catch on the drive shaft.....	7
Disassembling the drive adapter with safety catch on the drive shaft .....	7
Assembling and disassembling the drive adapter with separate drive adapter safety catch.....	7
Mounting the drive in the tube .....	7
Setting the limit positions.....	9
Information for the electrician .....	10
Disposal .....	10
Maintenance .....	10
Technical data dia. 45 .....	10
Certificate of Suitability.....	10
What to do if...? .....	11
Sample wiring diagrams .....	11

## General

These tubular drives are high-quality products with the following features:

- For use with roller shutters
- For use with sunblinds
- Easy limit switch setting on the drive
- Compatible with all of the drive manufacturer's control units for roller shutters and sunblinds.

Please observe these Assembly and Operating Instructions when installing and setting the equipment.



The date of manufacture comes from the first four digits of the serial number.

The numbers 1 and 2 indicate the year and the numbers 3 and 4 indicate the calendar week.

Example: 24th calendar week in 2012

Ser. No.:	1224XXXXX
-----------	-----------

### Explanation of pictograms

	<b>CAUTION</b>	CAUTION indicates a hazardous situation which, if not avoided, could result in injury.
	<b>ATTENTION</b>	ATTENTION indicates measures that must be taken to avoid damage to property.
		Denotes user tips and other useful information.

## Warranty

Structural modifications and incorrect installation which are not in accordance with these and our other instructions can result in serious injuries, e.g., crushing of limbs. Therefore, structural modifications may only be carried out with our prior approval and strictly in accordance with our instructions, particularly the information contained in these Assembly and Operating Instructions. Any further processing of the products which does not comply with their intended use is not permitted.

The end product manufacturer and fitter have to ensure that all the relevant current statutory, official and, in particular, EMC regulations are adhered to during utilisation of our products, especially with regard to end product manufacture, installation and customer advice.



## Safety instructions

The following safety instructions and warnings are intended to avert hazards and to prevent property damage and personal injury.

### Instructions for the user

#### General information

- The drive must be disconnected from its power source during cleaning and maintenance and when replacing parts.
- All work, including maintenance and cleaning, on electrical installations as well as other system parts must always be performed by trained technicians, in particular qualified electricians.
- Children from the age of 8 years and persons with reduced physical, sensory or mental capabilities or lack of experience and/or knowledge may use these devices, provided they are supervised or have been instructed in the safe use of the device, and have understood the hazards involved. Children must not play with the device.
- Systems have to be checked regularly by authorised specialists for wear and damage.
- Always put damaged systems out of operation immediately until they are repaired by an authorised specialist.
- Do not operate equipment if people or objects are within the danger zone.
- Observe the danger zone of the equipment during operation.
- Ensure that there is adequate clearance (at least 40 cm) between moving parts and adjacent objects.



#### Caution

#### Safety instructions for avoiding serious injuries.

- **Crushing or shearing points must be avoided or protected.**

### Instructions for installation and commissioning

#### General information

- Observe the safety instructions in IEC 60335-2-97. Please note that this list of safety instructions is not exhaustive, since it would be impossible for the standard to include all sources of danger. For example, the design of the operated product, the way the drive works in the situation it is installed in or even the way the end product is mounted in the end user's place of use cannot be taken into consideration by the drive manufacturer.

If any questions or uncertainties regarding the safety instructions contained in the standard arise, please contact the manufacturer of the part or end product in question.

- All applicable standards and regulations for electrical installation must be complied with.
- All work, including maintenance and cleaning, on electrical installations as well as other system parts must always be performed by trained technicians, in particular qualified electricians.
- Only use spare parts, tools and accessory devices which have been approved by the drive manufacturer.  
Unapproved third-party products or modifications to the system and its accessories represent a risk to your safety and the safety of others. This means that the use of unapproved third-party products, or modifications which have not been agreed with or approved by us, are prohibited. We do not accept liability for damage or injury arising from such actions.
- Position switch with OFF presetting within sight of the driven product, but away from moving parts, at a height of over 1.5 m. This must not be publicly accessible.
- Permanently mounted control devices must be positioned where they can be seen.
- Rated torque and duty cycle must be suitable for the requirements of the driven product.  
Technical data - rated torque and service life can be found on the type plate of the tubular drive.

- Hazardous moving parts of the drive must be installed at a height of over 2.5 m above floor level or any other surface from which the drive can be accessed.
- To ensure safe operation of the system after commissioning, the limit positions must be correctly set/programmed in.
- Drives with a S05RN-F or O5RN-F connecting cable may be used both indoors and outdoors.
- To connect the drive to the driven part, solely mechanical accessory components made by the drive manufacturer from the current product catalogue may be used. The components must be installed in accordance with the manufacturer's instructions.
- If the drive is used for shading solutions in a specially marked area (e.g., escape routes, hazard zones, safety areas), compliance with all applicable regulations and standards must be ensured.



### **Caution**

#### **Safety instructions for avoiding serious injuries.**

- **When electrical or electronic equipment and units are operated, certain components, e.g., the power supply unit, are live. Physical injuries or damage to property can result in the event of unauthorised interventions or failure to heed warnings.**
- **Be careful when touching the tubular drive, as it heats up during operation for technical reasons.**
- **Before installation, shut down all lines and control devices that are not essential for operation.**
- **Crushing or shearing points must be avoided or protected.**
- **When installing the drive, all-pole disconnection from the mains with a contact gap of at least 3 mm per pole must be provided (IEC 60335).**
- **If the mains connecting cable is damaged, it may only be replaced by the manufacturer. If the drive has a plug-in connecting cable, it must be replaced with the same type of mains connecting cable, which is available from the drive manufacturer.**

### **Attention**

#### **Safety instructions for avoiding property damage.**

- **Ensure that there is adequate clearance between moving parts and adjacent objects.**
- **The drive must not be carried by the mains connecting cable.**
- **All latching connections and fastening screws on the brackets must be checked to ensure that they are secure.**
- **Ensure that nothing rubs against the tubular drive, such as shading solution attachments, screws, etc.**



## Intended use

The type of tubular drive described in these instructions is intended solely for the operation of roller shutters and sun protection systems.

This type of tubular drive is designed for use in single systems (one drive per barrel).

The tubular drive must not be used in potentially explosive areas.

The connecting cable is not suitable for transporting the drive. Always carry the drive by the housing tube.

Other applications, uses and modifications are not permitted in order to protect the safety of the users and others, since these actions can impair the system's safety and carry the risk of personal injury and property damage. The drive manufacturer does not accept liability for damages or injury arising from such actions.

Always observe the information in these instructions when operating or repairing the system. The drive manufacturer does not accept liability for damage or injury resulting from improper usage.

## Installation

### Assembling the drive

#### Attention

**To connect the drive to the driven part, solely mechanical accessory components made by the drive manufacturer from the current product catalogue may be used.**

Prior to mounting, the fitter must ensure that the masonry and the system being motorised are sufficiently robust (drive torque plus weight of the shading solution).



#### Caution

**Electrical connections may only be carried out by a qualified electrician. Prior to assembly, the power supply must be disconnected and secured. Please give the enclosed connection information to the responsible electrical contractor.**

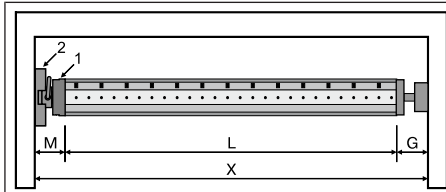

Calculate the space required at the side (M) by measuring the drive head (1) and wall bracket (2). The clear dimension of the box (X) minus the space required at the side (M) and idler (G) gives the length (L) of the barrel:  $L = X - M - G$ .

The space required at the side (M) varies depending on the combination of drive and wall bracket.

Then mount the wall bracket and idler. Ensure that the barrel is aligned at right angles to the wall and that sufficient axial play is allowed for the mounted system.

#### Attention

**When using rigid shaft connectors, closed brackets must be fitted. The tubular drive presses the closed curtain down to make it difficult for people to reach under it or raise it. Only use curtains made of sufficiently strong material, such as aluminium, steel or wood. To prevent damage to the curtain it must run in guide tracks from top to bottom.**

### Undoing the mounting pin

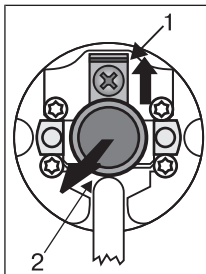

When pushed in, the mounting pin (2) locks automatically. To undo the mounting pin (2), push the tab washer (1) upwards and pull out the mounting pin (2).

## Drive adapter safety catch

### Assembling the drive adapter with safety catch on the drive shaft

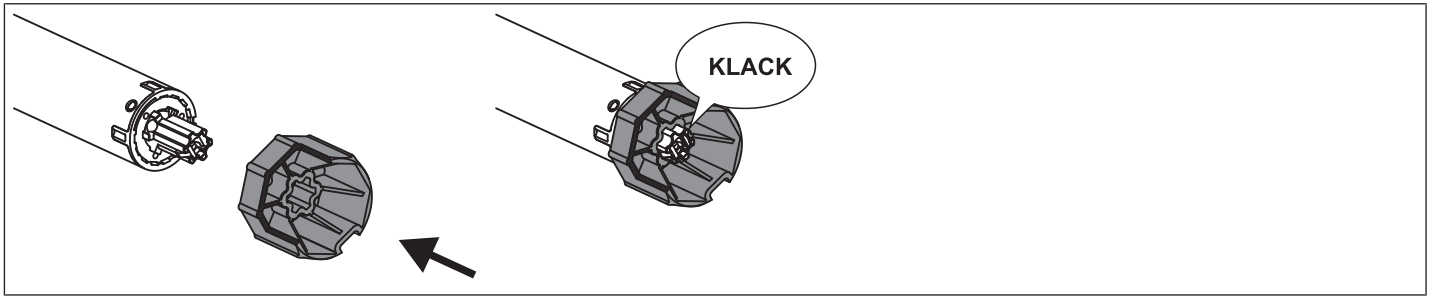

### Disassembling the drive adapter with safety catch on the drive shaft

Disassembly with disassembly tool, Item no. 4930 300 606 0

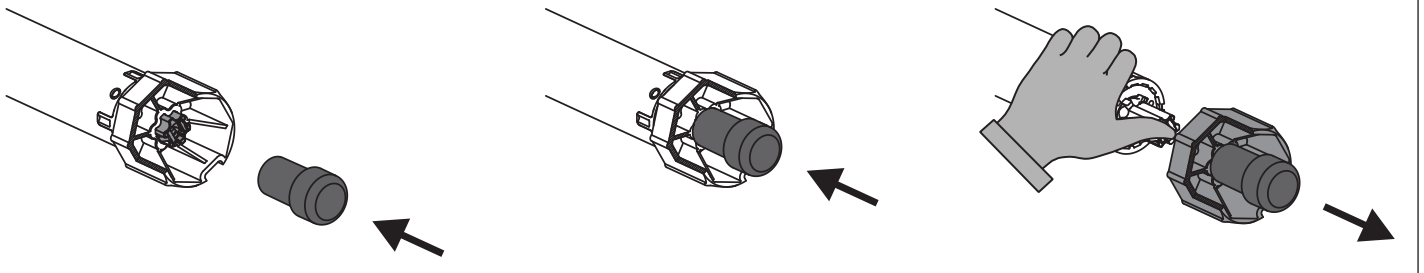

Disassembly with long nose pliers

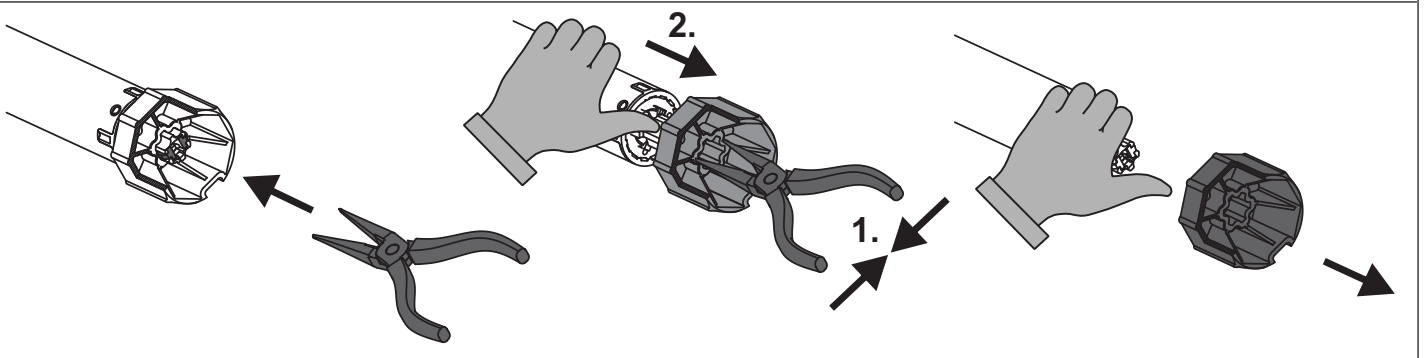

### Assembling and disassembling the drive adapter with separate drive adapter safety catch

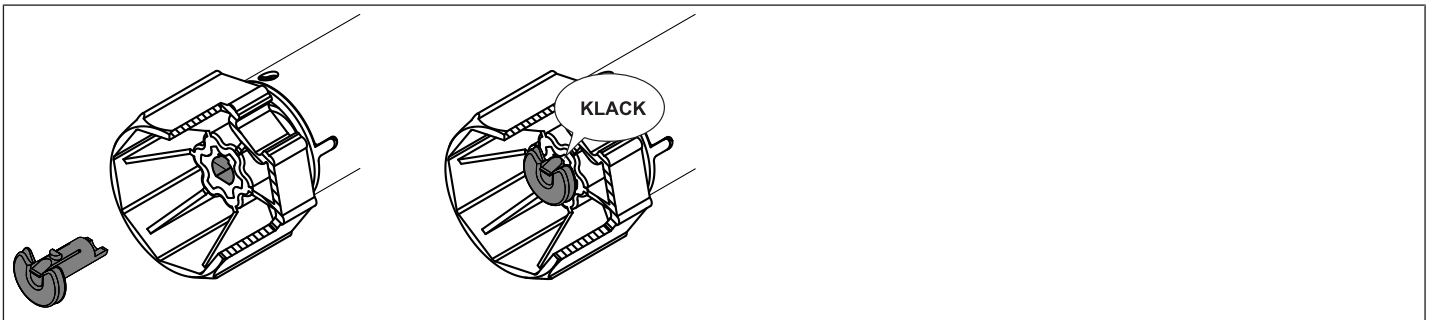

### Mounting the drive in the tube

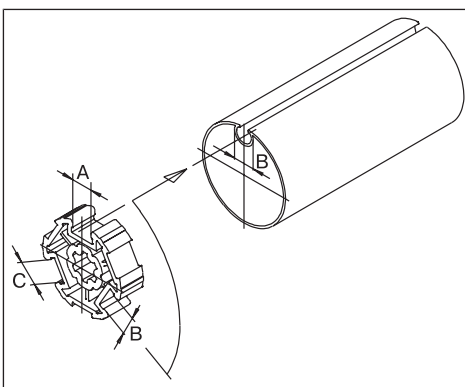

#### For profile tubes:

In the case of some drive adapters, tolerances of the groove widths in different barrels can be offset by rotating the drive adapter into a different groove recess. These groove recesses have different sizes and allow the drive to fit exactly.



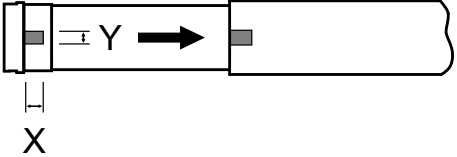

**For round shafts:**  
Measure the lug of the thrust ring (X, Y). Then notch the tube on the motor side, so the lug of the thrust ring can also be pushed into the shaft. There must be no play between the lug of the thrust ring and the shaft.

To ensure secure torque transmission for round shafts, we recommend screwing the drive adapter to the shaft (see the table below).

**Attention! When drilling into the barrel, never drill near the tubular drive!**

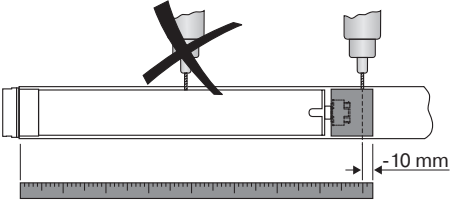

Size of drive [mm]	Drive adapter	Torque max. [Nm]	Fastening screws (4 units)
dia. 35-dia. 45	All	Up to 50	Self-tapping screw dia. 4.8 x 9.5 mm
dia. 58	Aluminium drive adapter	Up to 120	Countersunk screw M8 x 16 mm
dia. 58	diecast drive adapter	Up to 120	Self-tapping screw dia. 6.3 x 13 mm

We also recommend screwing the idler to the barrel.

### Attention

**Do not hammer the tubular drive into the tube or drop it into the barrel! The curtain can only be secured using springs or rigid shaft connectors. We recommend at least three pieces per metre of barrel.**

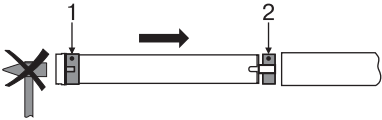

Assemble the tubular drive with the relevant ring (1) and drive adapter (2). If the ring has several grooves, select the groove which is a perfect fit and push the ring (1) onto the thrust ring.

Insert the tubular drive with the pre-assembled ring (1) and drive adapter (2) into the tube to achieve a form fit. Ensure that the ring and drive adapter are secure in the tube.

Mount the assembled unit comprising barrel, tubular drive and idler on the box and secure the drive with a split or spring pin according to the type of wall bracket fixing.

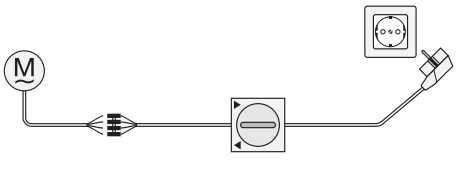

The drive can be operated either with the switch (Item no. 4901 001 158 0) or the operator control provided.

Connect the pigtail wires of the tubular drive to those of the same colour in the switch or operator control and switch on the power supply. Check the direction of travel. If the direction of travel of the shading solution does not correspond to the operator control, swap the black and brown pigtail wires of the tubular drive.

### Attention

**The switch is not suitable for continuous operation and has only been designed for start-up!**

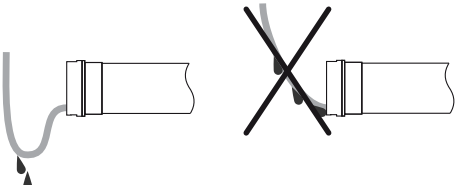

**Lay the connecting cable**

Lay the connecting cable up to the tubular drive, and fix The connecting cable and any antennae must not project into the winding chamber. Cover any sharp edges.



## Setting the limit positions

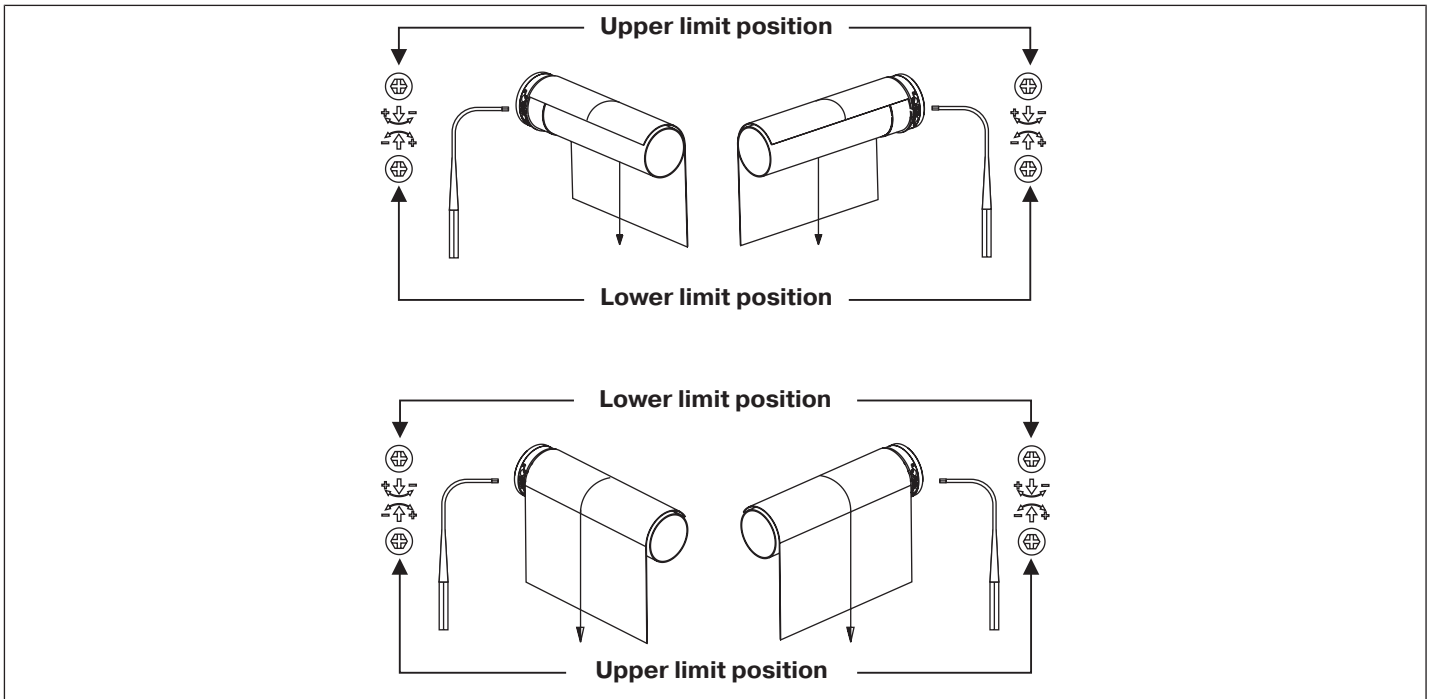

### Setting the lower limit position

1. Before the shading solution is fixed to the barrel, let the drive run DOWN until it switches off automatically.
2. By adjusting the lower limit position, position the barrel to make it easy to fix the shading solution to the barrel.

### Setting the upper limit position

Activate the UP switch. The drive rolls up the shading solution. Extend or reduce the range of travel by turning the corresponding set screw.



#### Note on roller shutter use

To make allowances for any changes in the length of the roller shutter, do not mount mechanical stops. Make sure that the individual laths cannot shift sideways.

During commissioning and subsequent use, ensure that the roller shutter curtain runs UP and DOWN smoothly and easily.

### Test for proper functioning

As a final check, run the shading solution to the limit positions in both directions again.

#### Attention

The tubular drives are designed for short-time operation (for the operating mode, please see technical data). An inbuilt thermal protection switch prevents overheating of the tubular drive. During commissioning (long drop distance or long running time), the thermostat may trigger. The drive will switch off. After a short cooling-down period, the system is ready for operation again.

The drive does not achieve its full duty cycle until it has cooled to ambient temperature. Avoid a situation where the thermal protection switch cuts in repeatedly.



## Information for the electrician

The tubular drives with mechanical limit switching must **not** be connected in parallel. The drive manufacturer offers a range of suitable controls for the simultaneous control of several drives.

Use external conductor L1 to control the up and down direction. Other devices or consumers (lamps, relays, etc.) must not be directly connected to the drive connecting cables. For this purpose, the drives and additional devices must be decoupled by relay controls.

When installing the drive, all-pole disconnection from the mains with a contact gap of at least 3 mm per pole must be provided.

### Attention

**Only use mechanically or electrically locked switching elements with a marked zero position! This also applies when drives with electronic and mechanical limit switching are used in the same system. The changeover time for switching the running direction must be at least 0.5 s. The switch and control must not execute simultaneous UP and DOWN commands. Protect the electrical connections from damp.**

**Once you have finished wiring everything to the control, ALWAYS check the right direction assignment of the drive to the control buttons UP and DOWN, EXTEND and RETRACT. If the drive is to be operated with devices which contain sources of interference, the electrician must ensure suitable interference suppression for the relevant devices.**

## Disposal

This product is made of various materials which must be disposed of properly. Find out about the applicable regulations on recycling or disposal for this product in your country.

The packaging material must be disposed of properly.

## Maintenance

These drives are maintenance-free.

## Technical data dia. 45

Type	R7/17M A
Rated torque [Nm]	7
Output speed [rpm]	17
Limit switch range	17 revolutions
Supply voltage	240 V AC / 50 Hz
Connected load [W]	95
Rated current consumption [A]	0.40
Mode	S2 4 min
Degree of protection	IP 44
Min. tube inside diameter [mm]	47
Emission sound pressure level [dB(A)]	≤ 70

## Certificate of Suitability



Certificate No.: SAA181406

## What to do if...?

Problem	Cause	Remedy
The roller shutter curtain is raised unevenly or not at all.	<ol style="list-style-type: none"> <li>1. One or more attachments have broken off.</li> <li>2. Lath has broken off.</li> </ol>	Repair system; then reset the limit positions.
Tubular drive stops arbitrarily; cannot be restarted in the same direction.	Roller shutter curtain keeps sticking; too much friction.	Repair system
Tubular drive does not run in the right direction.	Electrical connection faulty.	Check the electrical connection.

## Sample wiring diagrams

### Operation with single switch

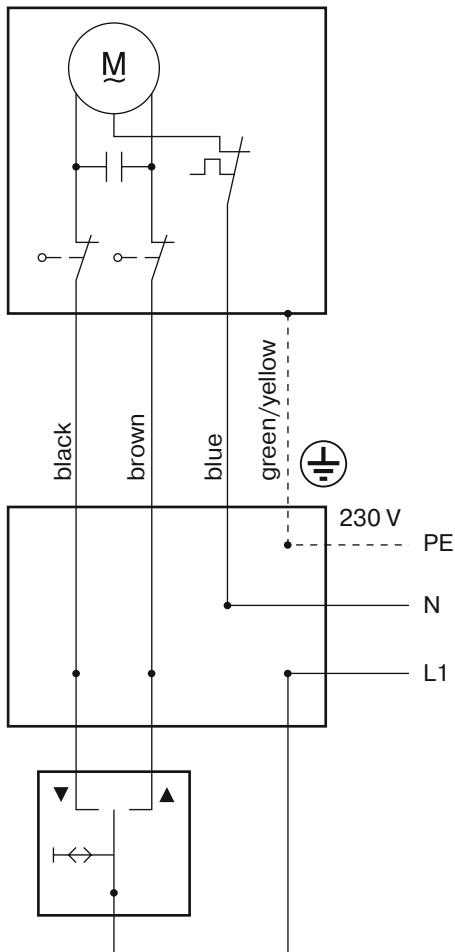

# Central, group and individual control using Centronic UnitControl UC42

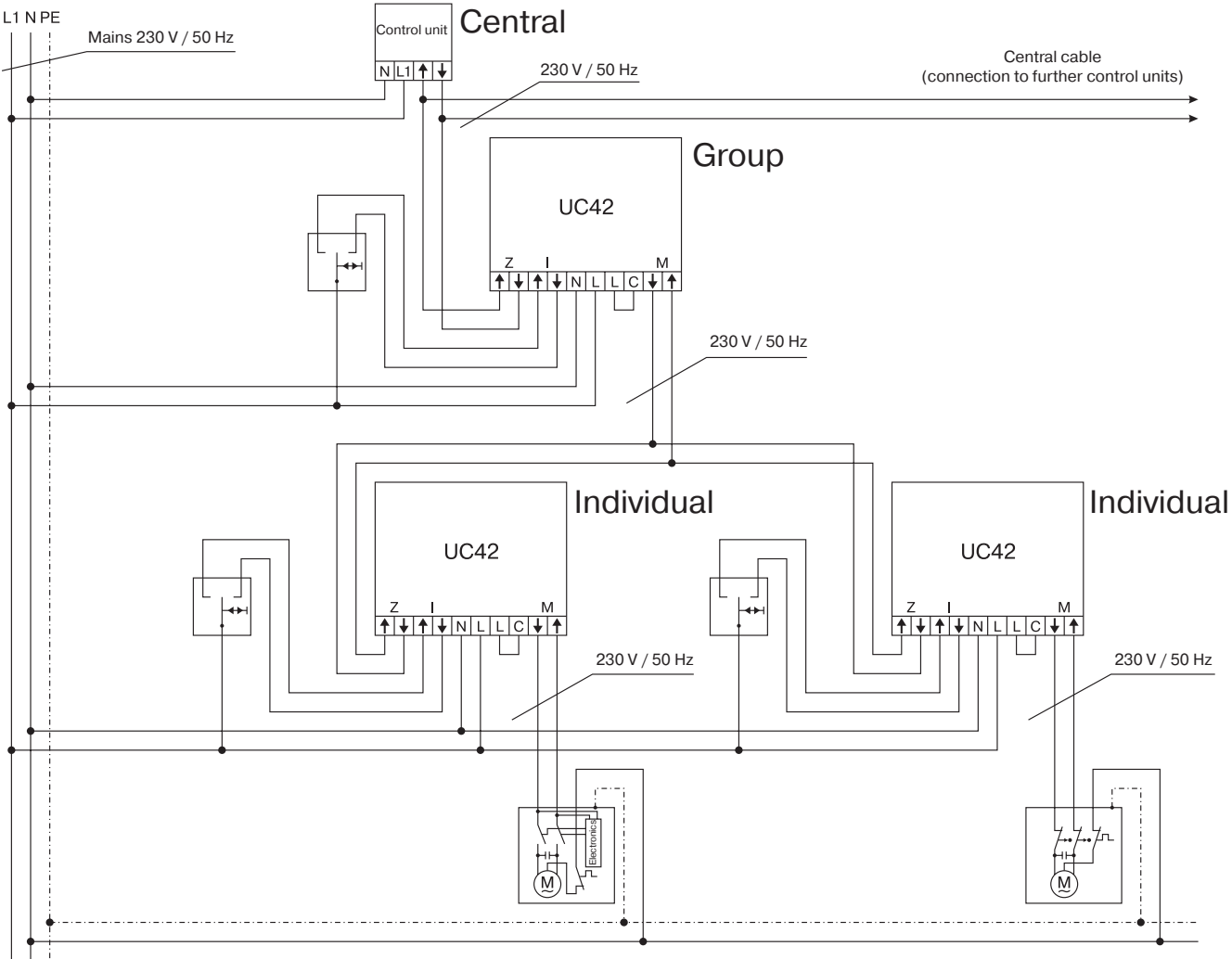









**BECKER**